

IMAGE 1

All in two solar batten light



Introduction ■

01

FRONT COVER



02

CONTENTS



03

MAIN FEATURES



04

PRODUCT PARAMETER



05

MAIN FEATURES



06

PRODUCT ADVANTAGES



07

APPLICATIONS



08

PACKAGE DETAILS



09

END



SOLA Solar LED Batten Light Kit

2600LM



What is solar batten light?

ESHINE Solar LED batten light is specially designed for retail & distribution market.

Can be widely used in many applications, such as office, home, garage, caravan, carports, bus stations, warehouses, camping tents, farm tents, sidewalks & alleyways, emergency camps, aid tents, caves, or many kinds of temporary or permanent accommodation structures, etc.

Solar LED batten light is a kit that contains everything - rechargeable lithium battery, solar controller, and solar panel. Easy installation in less than 5 minutes; It provides a high brightness level over a long period of time

TECHNICAL SPECIFICATIONS

Mode	SHL-08
Solar panel	
Mono-crystalline Tempered Glass Solar Panel	20W
Led	
CREE LED Number	112pcs >50000H
LED Module	1
CREE LED Emitter output (Max on peak)	14W
Efficiency	160lm/w
CREE LED illumination color	6000K
Battery	
Li-ion Battery Pack	76.96WH
Charging Time	8hrs by bright sunshine
Other information	
Product Material	Aluminum alloy material +pc
Operation Temperature	-25°C ~ 65°C
Lighting time	3-5nights after fully charged
Working mode	Mode1: 5H 100% - 7H 50% Mode2: 5H 50% - 7H 25%
Light Size (L x W)	710*328 mm
IP	66
Certificate	CE ROHS FCC ISO9001:2015
Warranty	3years

■ MAIN ADVANTAGE

*ULTRA THIN DESIGN * SUPER BRIGHT*

M U L T I - F U N C T I O N A L M O D E R N D E S I G N



D R A W E R D E S I G N F O R E A S Y R E P L A C E M E N T

■ MAIN FEATURES



▲
Option A
Split installation

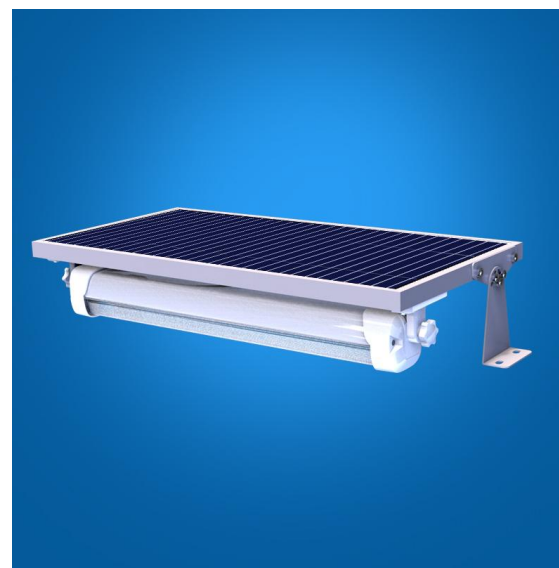

▲
Option B
Integrated installation

■ MAIN ADVANTAGE

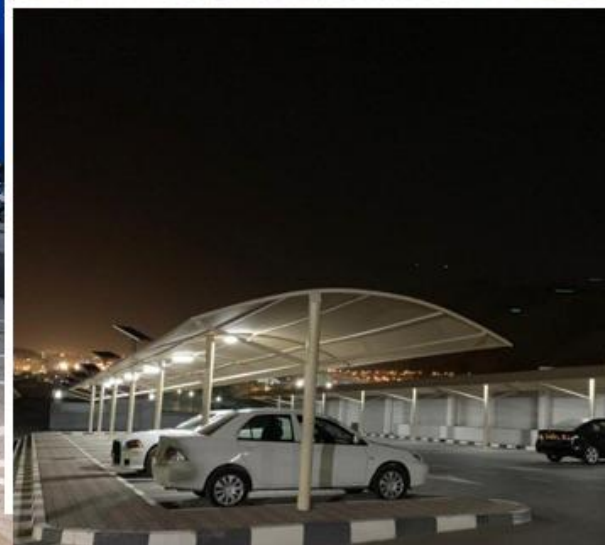

■ DIMENTION FIGURE

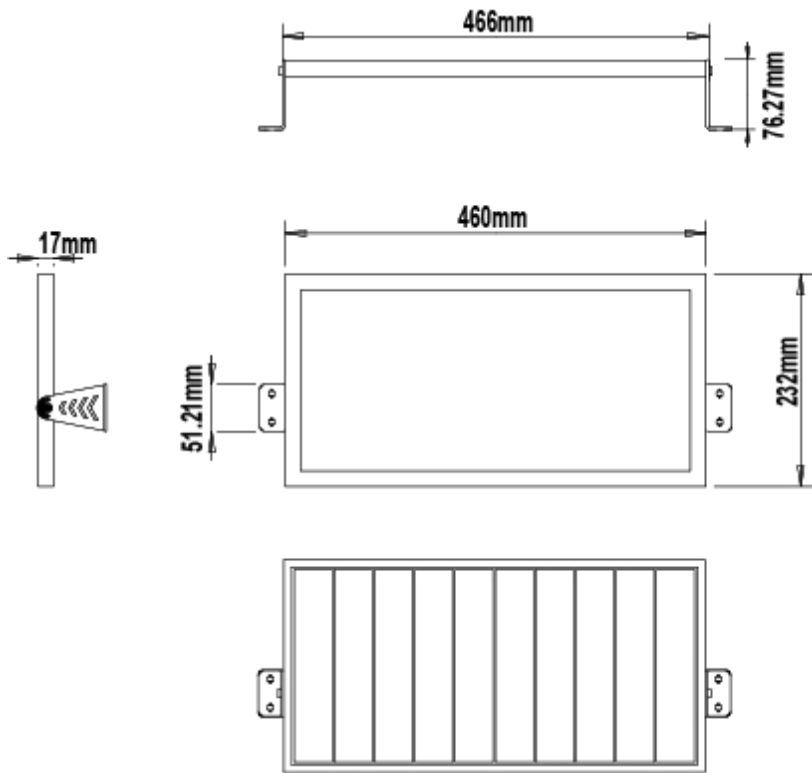

solar panel Dimensions

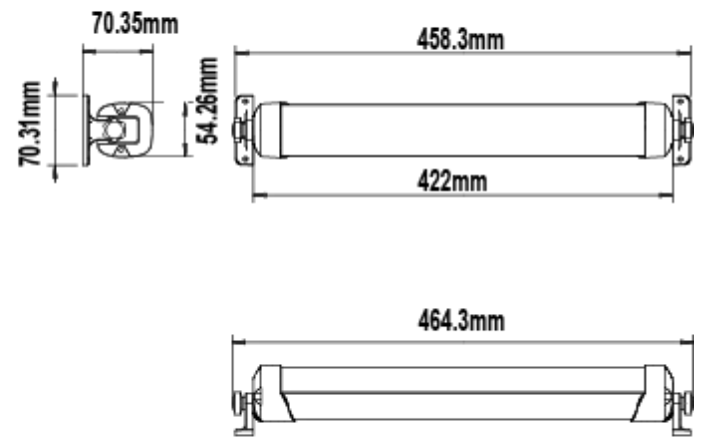

lamp tube Dimensions

High efficiency USA Cree LED 2600LM

PRODUCT DETAILS

QUALITY AND DETAILS MAKE A GOOD SOLAR LAMP TUBE

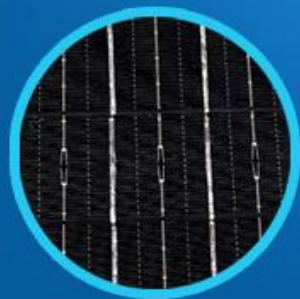
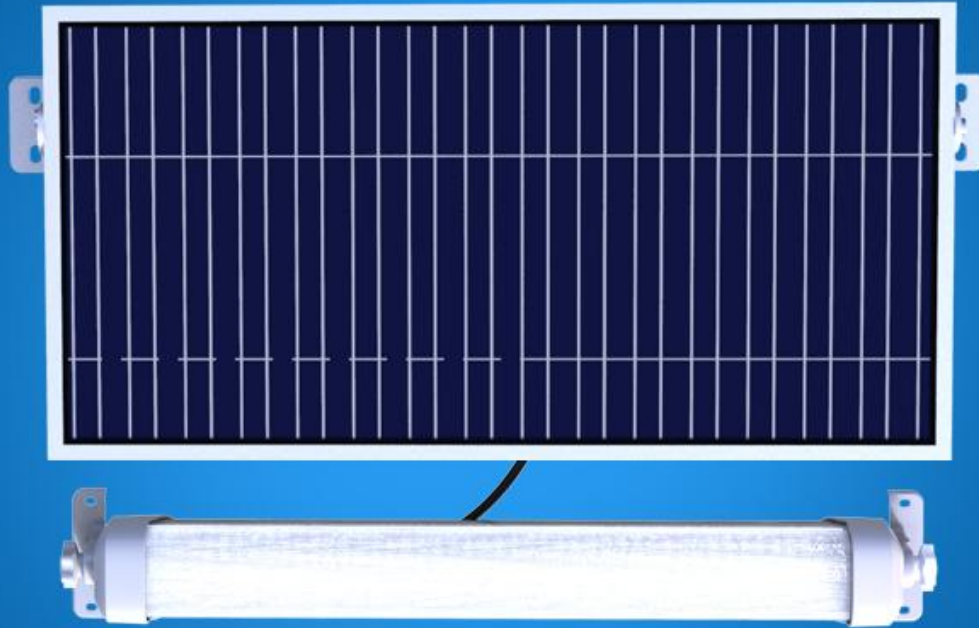

Monocrystalline silicon solar panel



intelligent switch



Highlight LED

Mode1: 5H 100% - 7H 50%

Mode2: 5H 50% - 7H 25%

Battery Indicator :30% 65% 100%

■ MAIN ADVANTAGE



Pearl cotton for protection

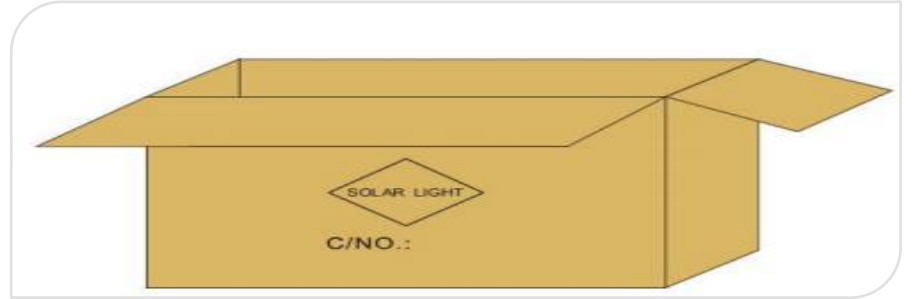

5-layer corrugated paper

Step1

Step2

	SHL-08
Packing details	1PC/CTN
Ctn Size (CM)	48*25*10cm
Gross weight	/
20GP load	/
40GP load	/
40HQ load	/



THANK
YOU